

Reference book

Legal Notice:

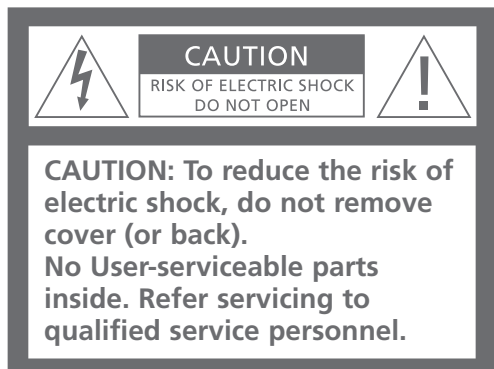

WARNING: To prevent fire or electric shock, do not expose this appliance to rain or moisture.



This symbol indicates that a dangerous voltage constituting a risk of electric shock is present within this unit.



This symbol indicates that there are important operating and maintenance instructions in the literature accompanying this unit.

For the Canadian market only!

CAUTION: To prevent electric shock do not use the polarized plug, attached to this apparatus, with an extension cord, receptacle or other outlet unless the blades can be fully inserted to prevent blade exposure.

BeoSound 3000 – the fully integrated music system

Whenever you reach out to operate the BeoSound 3000, the glass doors slide open as if by magic, inviting you in to the music.

The BeoSound 3000 is a fully integrated music system with both radio and CD player. Its compactness facilitates placement next to your favourite listening position.

All the operating buttons are located in one place. They are conveniently grouped according to type of function, so you can easily find your way around the close-up operation panel and operate the system.

Contents of the Reference Book

To get to know your Bang & Olufsen product two guides are at your disposal.



The Guide provides information on daily use. The Reference book gives a thorough overview of all aspects, installation and in-depth explanation.

To the right, you find the contents of the Reference book, all the chapters of the Guide are listed below:

- Your key to BeoSound 3000, 5
- Operation panel, 5
- Displays, 5
- CD player, 6
- Different ways of playing a CD, 6
- Favourite CD tracks only, 7
- Make series of CD tracks, 7
- Delete series of CD tracks, 7
- Radio, 8
- Volume, 8

How to set up BeoSound 3000

- 6 Placing your BeoSound 3000

Connect the cables

- 7 Aerial
- 7 Loudspeakers
- 7 Auxiliary equipment
- 7 BeoLink
- 7 To the mains

How to assemble BeoSound 3000

- 8 Mount the glass doors
- 8 Mount the cables
- 8 Mount the cable cover

BeoSound 3000 in an audio/video setup

- 9 BeoSound 3000 – without speakers – with a video system
- 9 BeoSound 3000 – with speakers – with a video system
- 9 BeoSound 3000 in another room

Adjust and set Sound

- 10 Sound adjustments
- 10 Survey of sound displays

Set the right time

- 11 Set the built-in clock

Tune in radio stations

- 12 Tune in stations
- 13 Move radio stations
- 13 Delete radio stations
- 13 Name radio stations

Make BeoSound 3000 start or stop at a specific time

- 14 Make a Timer to start or stop automatically
- 15 Check the Timers
- 15 Delete a Timer

Daily use of radio and CD player

- 16 Switch on the radio
- 16 Adjust volume
- 16 Switch on the CD player
- 16 Find tracks on a CD

BeoSound 3000 display indications

- 17 Understand and change the displays

Play CDs in different ways

- 18 Play tracks in random order
- 18 Repeat a CD
- 19 Repeat a track on a CD
- 19 Repeat a passage on a CD
- 19 Scan a CD

Play favourite CD tracks only

- 20 Select and store a series of tracks
- 20 Delete a series of tracks

Name your CDs

- 21 Name your individual CDs
- 21 See list of CD names
- 21 Delete CD names and series of tracks

Looking after BeoSound 3000

- 22 Cleaning BeoSound 3000
- 22 Handling your CDs

Beo4 remote control operation

- 23 Use the Beo4 remote control

Use with a video system – transfer sound from system to system

- 24 A fully integrated Audio/Video setup
- 24 An Audio/Video integrated setup

Set and enter a PIN code

- 26 Enter a PIN code
- 26 Switch on the PIN code
- 27 Change the PIN code
- 27 Switch off the PIN code
- 27 Using a Master code

Key to using this guide

Use this Key to identify what a button, source or status display looks like in an instruction sequence.

RADIO
CD
PLAY
A >>> B

Buttons on the BeoSound 3000 close-up operation panel or on the Beo4 remote control

CD
EDIT?

Lower display on BeoSound 3000

RANDOM
REPEAT

Displays on Beo4

How to set up BeoSound 3000

We recommend that you follow this procedure when you set up your BeoSound 3000:

- 1 Place the BeoSound 3000 where you want to use it.
- 2 Set up your speakers and any auxiliary equipment.
- 3 Connect all cables to their sockets on the rear panel of the BeoSound 3000 – remember not to connect it to the mains yet!
- 4 Arrange the cables in the cable cover grooves and attach the cover to the rear of the BeoSound.
- 5 Mount the glass doors.
- 6 Connect the products to the mains.

Placing your BeoSound 3000...

- Make sure that the BeoSound 3000 is set up, placed and connected, in accordance with the instructions in this guide.
- Place your BeoSound 3000 on a firm surface, preferably on the table, sideboard or stand where you want it placed permanently.
- The BeoSound 3000 is designed for indoor use in dry, domestic environments only, and for use within a temperature range of 10–40° C (50–105° F).
- Avoid placing the system in direct sunlight, near radiators or other sources of heat.
- Allow a space of at least 5cm above and to each side of the BeoSound 3000 for adequate ventilation. Remember to leave enough space at the sides for the glass doors to open.
- If you want to hang the BeoSound 3000 on a wall, make sure that you use the correct size and type of screws and wall plugs for mounting the wall bracket (optional accessory) and the BeoSound. The type of screws and wall plugs will depend on the material and construction of the wall.
- Do not switch on the mains for any products in your system, until after you have connected all the cables (see opposite page, p. 7).

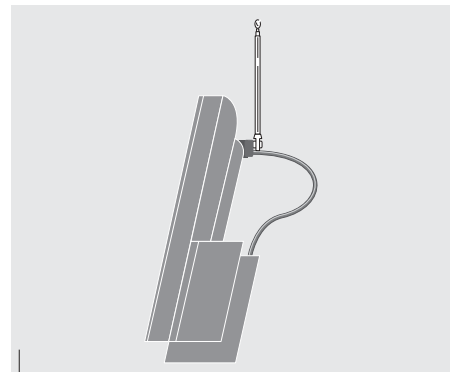

If no permanent FM aerial connection is available, an indoor aerial may be hooked onto the clamp on the back of the BeoSound 3000.

You can use your BeoSound 3000 in a stand-alone setup or connected to a Bang & Olufsen video system using the Master Link cable. The Master Link socket on the back of BeoSound 3000 can also be used for BeoLink distribution. The BeoLink system allows you to listen to the BeoSound 3000 in any room you like, via extra speakers*.

Use the diagram and the graphics imprinted on the socket panel for reference, when locating the sockets.

Please do not connect the BeoSound to the mains until you have finished the setting-up procedure.

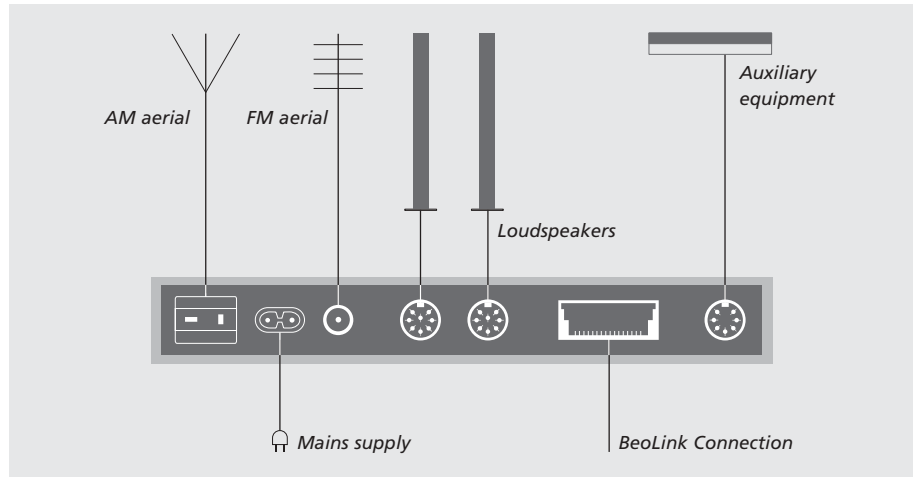

Aerial

Connect your FM aerial to the socket marked FM and your AM aerial, if any, to the socket marked AM.

When using an AM loop aerial, tune in to the radio station you want, then turn the aerial horizontally until you receive the best possible signal.

Loudspeakers

Connect your active speakers to the sockets marked POWER LINK.

You may choose to loop the signals through from speaker to speaker, please refer to the User's guide for your BeoLab loudspeakers, or you may connect one speaker to each of the two sockets.

Remember to set the L • R • LINE switch on the BeoLab speakers to L and R (left and right), respectively.

Note: If you wish to connect the BeoLab 2500 loudspeakers, please refer to the guide supplied with the speakers

Auxiliary equipment

Connect your auxiliary equipment to the socket marked AUX. This socket enables you to use compatible Bang & Olufsen equipment, e.g. an audio tape recorder or a record player. The socket may also accommodate equipment of other makes.

BeoLink connection

The socket marked MASTER LINK should be used when you connect your BeoSound 3000 and a compatible Bang & Olufsen video system.

Mains supply

Plug the mains lead into the socket marked ~, but do not switch on at the mains yet.

*NOTE! Please contact a Bang & Olufsen retailer for further information on the BeoLink system and information on auxiliary equipment.

How to assemble BeoSound 3000

When you have finished the setting up procedure, described on the previous page, you must mount the glass doors and the cable cover.

Mount the glass doors

The labels on the back of the glass doors indicate which end should be pointing upwards, and which side of the glass door should point towards the middle of the BeoSound 3000.

- Fasten the two glass doors, one at a time, to the front of the BeoSound 3000 by pressing their fastening points into the corresponding fastening sockets on the BeoSound.
- Press gently on each of the fastening points until you hear a click. The click indicates that the glass doors are mounted properly.

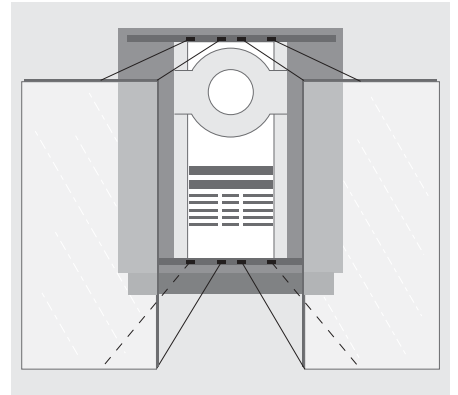

Arrange the cables

Arrange the connector cables in the cable cover as shown to the right. You can fasten the cables with tape to keep them in place before you mount the cable cover to the rear of BeoSound 3000.

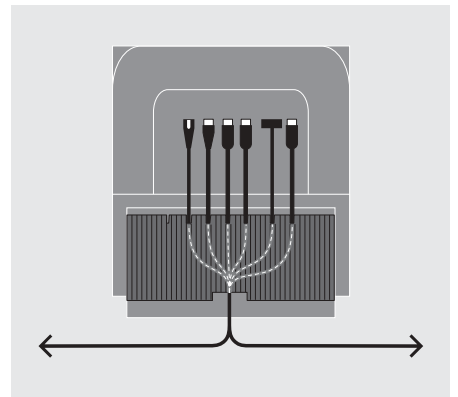

Mount the cable cover

Fasten the cover – with the cables attached – to the grill on the BeoSound rear panel:

- Insert the bottom row of pegs into the grill.
- Push the top row of pegs into the grill.
- Pull the cable cover upwards until the pegs fit properly with the grill.

Note: Do not plug in the cables before the cable cover is mounted

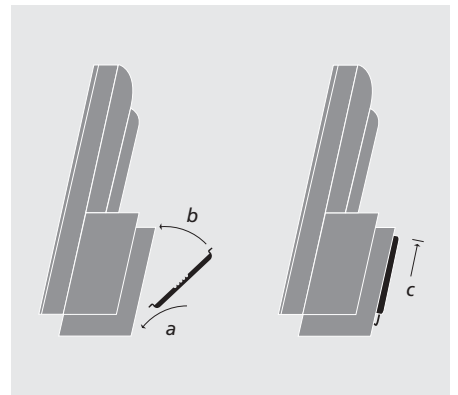

NOTE! Treat the glass doors with great care. If they are cracked or chipped, or damaged in any other way, they should be replaced immediately as they could otherwise cause bodily harm.

You can order replacement doors through a Bang & Olufsen retailer.

When you have connected your BeoSound 3000 to the mains, you must make sure that it is set up to function with the other products you have connected, if any. This means that you must programme the BeoSound 3000 option. If you have only connected speakers to the BeoSound, you do not have to make this programming.

The BeoSound 3000 has three different option settings:

Option 0. Used in a fully integrated Audio/Video system with no speakers connected to the BeoSound 3000. The sound is reproduced through the speakers in the TV, or through speakers connected to the TV.

Option 1. Used when the BeoSound is used on its own or in an Audio/Video integrated setup, with active speakers connected to the BeoSound 3000 (factory setting).

Option 2. Used in a two-room Audio/Video integrated setup.

The programming is done with a Bang & Olufsen remote control...

Using a Beo4...



Hold the • button down while pressing LIST

Now let go of both buttons

Press LIST until OPTION? is displayed

Press GO

Press LIST once to display A.OPT

When A.OPT is blinking in the Beo4 display...
Key in the appropriate number (0, 1 or 2)

Using a Beolink 1000...



Press SOUND

Key in the appropriate number (0, 1 or 2)

Press STORE

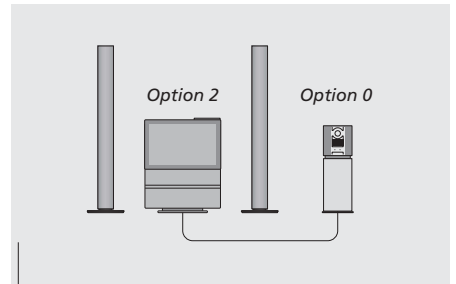

A fully integrated Audio/Video system.

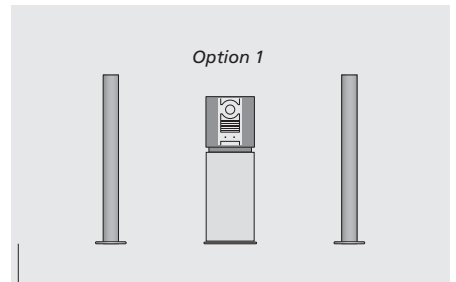

The BeoSound 3000 as a stand-alone system.

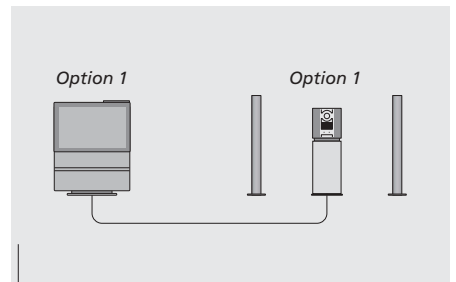

An Audio/Video integrated system set up in one room.

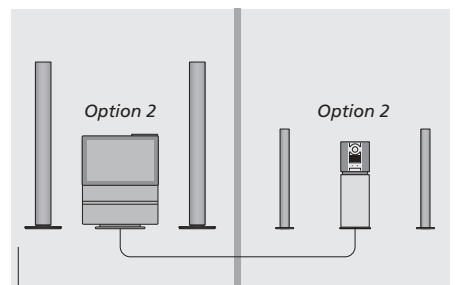

An Audio/Video integrated system set up in two rooms.

Adjust and store sound

All sound levels are set to neutral values from the factory, but you can make your own sound adjustments and store them.

If you store a volume level, BeoSound 3000 will start playing at this level each time you switch it on.

The BeoSound 3000 also features a loudness function which you can activate or deactivate as you like. The loudness function makes the music more dynamic. It compensates for the human ear's lack of sensitivity to high and low frequencies when listening to low music.

If you do not store the sound adjustments you make, BeoSound 3000 will return to the preset sound levels once you switch it off.

If you only want to adjust volume, simply press the buttons \wedge or \vee directly to turn the volume up or down.

Sound adjustments

You can adjust the volume, bass and treble levels or alter the balance between the left and right speakers of the BeoSound. This function enables you to direct the sound emerging from the speakers towards your favourite listening position.

SOUND VOL 28	Press SOUND to access the sound adjustment function. VOL and the current volume level appears
\blacktriangle \blacktriangledown	Use to raise or lower the sound levels
PLAY BAL ><	Press PLAY repeatedly to display the different sound displays, e.g. BAL ><
\ll \gg	Use to adjust balance
PLAY STORE ?	Press PLAY repeatedly until STORE ? appears
STORE STORED	Press STORE to store the current sound levels. STORED appears

Note: The buttons STORE and PLAY can be used interchangeably to accept what is shown in the display. However, STORE acts as a short cut, skipping intermediate levels and stores your settings directly.

Displays shown during sound adjustment...

VOL 34	<i>Volume level</i> Volume can be adjusted in steps of two within a range of 00 to 72
BAL ><	<i>Balance setting</i> Balance can be adjusted within a range of 7 to either side
BASS 0	<i>Bass level</i> Bass can be adjusted within a range of -5 to +5
TREB 0	<i>Treble level</i> Treble can be adjusted within a range of -5 to +5
LOUD ON	<i>Loudness setting</i> Indicates if loudness is switched on or off

NOTE! When BeoSound 3000 is used in a fully integrated Bang & Olufsen Audio/Video system, sound must be adjusted as described in the guide for the video system. When you press the SOUND button, the display will read USE TV.

Set the right time

The BeoSound 3000 has a built-in clock with time, date and year. You must set the clock yourself.

If you want to make use of the Timer function described on page 14 – 15, you must first make sure that the built-in clock in the BeoSound 3000 has been set correctly.

Set the built-in clock

It is necessary to set both the time, date and year.

CLOCK 14 : 45	Press CLOCK to access the clock function. The time appears
▲ ▼	Press to change to the exact time, if necessary
0 – 9	Alternatively key in the exact time
PLAY 23 AUG	Press PLAY to accept. The date appears
▲ ▼	Press to change the date, if necessary
PLAY 2000	Press PLAY to accept. The year appears
▲ ▼	Press to change the year, if necessary
PLAY STORE ?	Press PLAY to accept. STORE ? appears
STORE STORED	Press STORE to store the new setting. STORED appears

NOTE! When the BeoSound 3000 is used in a fully integrated Bang & Olufsen Audio/Video system, the clock must be set in the video system, the CLOCK button on BeoSound 3000 can then be used to simply show the time.

Tune and edit radio stations

You can let BeoSound 3000 find the available radio stations for you, and then store them on a program number of your own choice. You then access the station directly by keying in the appropriate program number or stepping through the stored stations.

You can also key in the exact frequency of a radio station and store it under a program number.

You can store up to 60 radio stations. In order to distinguish between the different stations more easily, you can give them a short name of your own choice. If you do not name a station, a name, transmitted by the broadcaster, may be shown in the display.

Tune in radio stations

Letting the BeoSound 3000 tune in your radio stations, ensures that you get all available stations. Once you have found a radio station, you can fine tune it, if the reception is poor.

RADIO	Press RADIO to switch on the radio	...	PLAY P 15 ?	Press PLAY to accept – the first available program number appears
TUNE FM ?	Press TUNE to access the tuning function. FM ? appears	▲ ▼	▲ ▼	Press to switch to a different program number
▲ ▼	Switches from FM to AM, or vice versa	PLAY FM 88.9	0 – 9	Or, key in the program number you want
PLAY FM 88.9	Press PLAY to select AM or FM. FM or AM and the current frequency appears	▲ ▼	PLAY STORED	Press PLAY to store the station on the displayed program number. STORED appears, indicating that the station is stored
▲ ▼	Press to search for a radio station – up or down the frequency band	0 – 9		*Note: When the requested station is found, you can skip the fine tune and stereo/mono selection by pressing STORE instead of PLAY. Now just enter a program number and press PLAY or STORE to store the station.
0 – 9	Or, key in the exact frequency	PLAY FINE 0		
PLAY FINE 0	Press PLAY to accept*. FINE 0 appears	▲ ▼		
▲ ▼	Press to fine tune, if necessary	PLAY STEREO ?		
PLAY STEREO ?	Press PLAY to accept. STEREO ? appears	▲ ▼		
▲ ▼	Switches from STEREO to MONO	...		

NOTE! If the stereo signals are not strong enough to produce acceptable sound, the BeoSound 3000 automatically switches to mono. You can also select mono manually, if necessary.

Move stored radio stations

If you have found a radio station and stored it under the first available program number, you can later move it to a different program number if you wish.

TUNE FM ?	Press TUNE to tune the station. FM ? (or AM ?) appears
PLAY	Press PLAY to accept
STORE STORE ?	Press STORE to move the station you are listening to. STORE ? appears
PLAY P 15 ?	Press PLAY to store the station again. The program number appears
1 0	Key in the number on which you want to store the station, for example 10
STORE STORED	Press STORE again to store the station. STORED appears, indicating that the station is stored on the chosen number

Note: The station still remains on the original program number and is then copied to the new program number. The name you may have given to the station is not moved to the new position.

Delete radio stations

You can delete a stored and named radio station at any time.

0 – 9 RADIO 7	Press one of the number buttons to select a radio station
DELETE DELETE ?	Press DELETE to delete the radio station you are listening to. DELETE ? appears
DELETE DELETED	Press DELETE again to delete the station. DELETED appears, indicating that the radio station is deleted

Name radio stations

You can give a short name of your own choice to all the stations you have stored. The name may contain up to 8 characters, including numbers. The name of the station you are listening to appears in the display.

NAME A _ _ _ _ _	Press NAME to access the naming function. A is blinking in the first character position
▲ ▼	Press to switch between characters
▶▶ D _ _ _ _ _	Press to move to the next character position – Continue to enter the whole name
STORE STORE ?	Press STORE to be able to store the name. STORE ? appears
STORE STORED	Press STORE* again to store the name. STORED appears, indicating that the name is stored

*Note: If you press DELETE instead of STORE, only the name of the station is deleted.

Start or stop at a specific time

You can make BeoSound 3000 start or stop playing at designated times throughout the day and week.

The BeoSound 3000 memorises up to 15 such Timer programmings and you can use it to e.g. wake you up in the morning to the sound from either your favourite CD or radio program. If, for example, you want the BeoSound 3000 to stop playing at a specific time in the evening, you just make a Timer with STANDBY as the source.

If you set a Timer for Monday, Tuesday and Thursday, the Timer will be repeated on these days only, every week.

Your Timers can be changed or cancelled, at any time.

Please note that when BeoSound 3000 is used in a fully integrated Bang & Olufsen Audio/Video system, the system Timer must be set as described in the guide for the video system. When you press the TIMER button, the display will read USE TV.

Set a Timer

Once you have pressed the TIMER button to get started, programming a new Timer is just like having a dialogue with the display. If you press any other button or switch to CD before the Timer has been stored in BeoSound 3000, the Timer is cancelled.

TIMER NEW ?	Press TIMER to access the Timer function. NEW ? appears	...	◀▶	Press to move between the days
PLAY RADIO ?	Press PLAY to make a new Timer. RADIO ? appears		▲	Press to include a day
			▼	Press to exclude a day
			MT T SS	The selected days are displayed
▲	Press to switch between the available sources		PLAY STORE ?	Press PLAY to accept the days shown in the display. STORE ? appears
▼			PLAY STORED	Press PLAY to store the Timer. STORED appears, indicating that your Timer is stored
PLAY P. NO 12 ?	Press PLAY to select a source when it is displayed – If you have selected radio, the program number appears		ON/OFF	Press to activate the Timer and cut the loudspeakers connected to BeoSound 3000 in or out
				A green indicator light will show when the Timer setting is ON
▲	Press to step between program numbers			
▼				
PLAY ON 20:00	Press PLAY to accept. A start time appears			
0 – 9	Key in the start time you want			
PLAY OFF 20:00	Press PLAY to accept. A stop time appears			
0 – 9	Key in the stop time you want			
PLAY MTWTFSS	Press PLAY to accept. MTWTFSS appears. The letters represent the 7 days of the week, starting with M for Monday			

Note: If you have made a mistake and do not wish to store your Timer, pressing ▲ when STORE ? is displayed, will change the display to EXIT ?. Press PLAY to exit the Timer function without storing the Timer.

If you make a STANDBY Timer, then all you need to store is a stop time.

NOTE! The list of sources shown in the display contains N.MUSIC (for music tracks stored on your PC) and N.RADIO (for radio sites on the Internet). These sources are available if you have connected your BeoSound 3000 to BeoLink PC 2 and have access to the Internet).

Check the Timers

You can check your Timers, the check function can also be used to correct Timers.

TIMER NEW ?	Press TIMER to access the function. NEW ? appears
▲ CHECK ?	Press to switch the display to CHECK ?
PLAY	Press PLAY to see the Timers
▲ ▼	Press to leaf through the programmed Timers
RADIO 12 PLAY	If you wish to make corrections, press PLAY when the Timer is displayed
▲ ▼	Press to change source, if required
PLAY	Press PLAY to accept, if you have changed the source
0 – 9	Key in your corrections
PLAY OK ?	Press PLAY to accept. OK ? appears
PLAY STORED	Press PLAY to store. STORED appears, indicating that your corrected Timer is stored

Delete a Timer

When you call up a list of your Timers, you can delete any Timer you want.

TIMER NEW ?	Press TIMER to access the function. NEW ? appears
▲ CHECK ?	Press to switch the display to CHECK ?
PLAY	Press PLAY to see the Timers
▲ ▼	Press to leaf through the programmed Timers
RADIO 12	When the Timer is displayed
DELETE DELETED	Press DELETE to delete it. DELETED appears, indicating that the Timer is deleted

Daily use of radio and CD player

To be able to use the radio, you must first tune in the radio stations you want, and store them on program numbers of their own, see page 12.

Once you have loaded a CD, press CD to listen to it. Playing will continue until the CD has reached the end, then BeoSound 3000 will switch to standby after 30 minutes if you do not operate it.

While listening to either radio or CD, you can adjust the volume up or down at all times by means of the \wedge and \vee buttons on the close-up operation panel.

Switch on the radio

When you switch on the radio, it automatically selects the station you listened to last.

RADIO	Press RADIO to switch on the radio
0 – 9	Use the number keys to select a stored station
\blacktriangle	Step through all stored stations
\blacktriangledown	
•	Switch to standby
\wedge	Adjust the volume up
\vee	or down
MUTE	Silences the speakers immediately. Press again to recall the sound

Note: Pressing 0 will swap between present and previous radio station

Play a CD

When you play a CD, you can stop it at any time. If you select another source, the CD stops automatically. You can select specific tracks or step through the tracks on the CD. When you search through a CD, searching will continue for as long as you keep your finger on the button. When you lift your finger off the button, the CD resumes playing.

CD	Plays the CD in the compartment
0 – 9	Plays specific track numbers
\blacktriangle	Plays the next track
\blacktriangledown	Plays the previous track
STOP	Pauses playing
PLAY	Resumes playing
\blacktriangleright	Searches forwards on the CD
\blacktriangleleft	Searches backwards on the CD

Keep the button pressed down until you have reached the point you want

The displays on BeoSound 3000 give you various types of information.

The upper display gives you specific information on the CD player only. Track numbers are always shown and the number of the playing track is blinking. As the tracks are played, the numbers disappear. The lower display informs you of the source you have chosen and guides you through setting up and programming sequences.

You can switch between different types of information by pressing DISPLAY repeatedly when the radio or CD player is switched on.

Three different display settings are available for the radio:

- 1 Program name
- 2 Program number
- 3 Radio frequency

Also three display settings are available for the CD player:

- 1 Name of CD
- 2 Track number
- 3 Elapsed time of current track



The radio station named CLASSIC is playing



Radio program 3 is playing.



The current radio station is transmitting on FM frequency 94.6.



The ten tracks on this CD will be played in random order.
The name of the CD is MOZART*.



The CD is being scanned.
The current track number is 5.



This edited CD is being repeated
The current track has been playing for 2 minutes and 15 seconds.

*NOTE! In order to display CD names, you must name the CD, see page 21 for further instructions.

Playing CDs in different ways

Apart from just playing a CD, you can play tracks on a CD in random order and also repeat the CD for up to 12 hours on end. It is also possible to make the CD player repeat either a track or just a specific passage on a CD for up to 12 hours.

You can use the repeat function in conjunction with the random play function, which means that the tracks will be played in a different order, each time the CD is repeated.

If you use the scan function, the first 15 seconds of each track on the CD is played.

Play tracks in random order

The random play function plays all the tracks on the CD in random order.

RANDOM ON	Press RANDOM while the CD is playing. ON appears – and RANDOM is shown in the upper display
RANDOM OFF	Press RANDOM twice to cancel the random play function. OFF appears

Note: If you cancel the random play function while the CD is playing, all tracks beyond the current track number will be played in chronological order, even if they have already been played while the random play function was activated. The random function is not cancelled when you switch off BeoSound 3000.

Repeat a CD

You can play the whole CD over and over for up to 12 hours.

REPEAT ON	Press REPEAT while the CD is playing. ON appears – and REPEAT is shown in the upper display
REPEAT OFF	Press REPEAT twice to cancel the repeat function. OFF appears

Note: If you switch off the BeoSound 3000, or if you select another source, the repeat function will also be cancelled.

Repeat a track on a CD

You can repeat a single track on a CD for up to 12 hours.

REPLAY

ON

Press REPLAY when you are listening to the track you want repeated. ON appears – and REPEAT is shown in the upper display

REPLAY

OFF

Press REPLAY twice to cancel the function. OFF appears

Note: If you switch off the BeoSound 3000, or if you select another source, the repeat function will also be cancelled.

Repeat a passage on a CD

The CD player can be instructed to repeat only a certain passage on the CD over and over.

A>>>B

Press A>>>B at the start of your passage. A is shown in the upper display

Playing continues uninterruptedly



It is possible to search forward to the place where you want the passage to end

A>>>B

Press A>>>B a second time to set the end of your passage. A>>>B and REPEAT are shown in the upper display

A>>>B

Press A>>>B to cancel the A – B repeat function

Note: If you switch off the BeoSound 3000, or if you select another source, the A>>>B repeat function will also be cancelled.

Scan a CD

Only the first 15 seconds of each track are played. When the entire CD has been scanned, the CD is played in full.

SCAN

Press SCAN to scan the CD. SCAN is shown in the upper display



Press while scanning to move between tracks

0 – 9

Or press the number keys to select a track you want scanned

PLAY

Press PLAY to cancel the scanning process and play the remaining tracks in full

Play favourite CD tracks only

The edit function enables you to program series of tracks for your individual CDs and memorise them permanently. Editing a CD means that you include or exclude each track on the CD while scanning it as described on the previous page. So, whenever you load such an edited CD, only the selected tracks will be played. The selected tracks are played in numerical order. When you play an edited CD, only the selected CD tracks are played, and CD ED appears in the display. However, you can still choose to play all the tracks on the CD.

Play or delete a series of tracks

Once you have edited a CD and selected your own series of tracks, then every time you play the CD it starts playing the series of tracks you have chosen. But you can choose to listen to the entire CD. You can also delete the series of tracks you have made, to always play the CD in full.

CD

Press CD to play your edited series of tracks. CD ED is shown in the upper display

To play the entire CD...

Press CD-ALL

CD-ALL

EDIT

EDIT ?

While the edited CD is playing, press EDIT to delete the series. EDIT ? appears

DELETE

DELETED

Press DELETE to delete the series altogether. DELETED appears

Select and store a series of tracks

Before making your own series of tracks you must start playing the CD. If you do not make a selection of whether to include or exclude the track being played, the track is automatically included. If you choose to leave the function before you have included or excluded all the tracks on the CD, the remaining tracks will be regarded as excluded.

EDIT

EDIT ?

Press EDIT while the CD is playing. EDIT ? appears

PLAY

EDITING

Press PLAY to start scanning the CD. EDITING appears – and SCAN is shown in the upper display



Press ▲ to include a track number in the series



Press ▼ to exclude a track number from the series

EDIT OK ?

EDIT OK ? appears when the last track has been included or excluded

PLAY

STORED

Press PLAY to store the series. STORED appears, indicating that your series is stored

STORE

EDIT OK ?

Or, press STORE before all tracks have been scanned. EDIT OK ? appears

STORE

STORED

Press STORE to store the series. STORED appears, indicating that your series is stored

NOTE! You can make series of tracks for up to 200 different CDs. If you exceed this limit, the display will read FULL, and you will have to delete a series of tracks before you can make another.

Name your CDs

To distinguish between your individual CDs, you can name them. The name will then be shown in the display when you load the CD. You can store a total of 200 names in your BeoSound 3000. Each name may contain up to 8 characters, including numbers.

Name a CD

The CD you are naming must be playing in the BeoSound 3000. If the CD has already been named, you can change the name or delete it, or you can just leave the function by pressing CD.

NAME A _ _ _ _ _	Press NAME to access the naming function. A is blinking in the first character position
▲ ▼	Press to switch between characters
▶▶ M _ _ _ _ _	Press to move to the next character
STORE STORE ?	Press STORE to complete the naming process. STORE ? appears
STORE STORED	Press STORE* again to store the name. STORED appears, indicating that the name is stored

*Note: If you press DELETE instead of STORE, only the name of the CD is deleted.

See the list of names

You can call up a list of CD names in the display. When the list is displayed, you can delete the names and any stored series of tracks at the same time.

NAME NAME MEMORY DISC 1	While any CD is playing press NAME twice to access the memory function. MEMORY appears briefly, then the name of the current CD blinks. If it has no name, the disc number, e.g. DISC 1, appears
▲ ▼	Press to list the names or numbers one by one
DELETE DELETE ?	Press DELETE to delete a name and series of tracks while the appropriate name is displayed. DELETE ? appears
DELETE DELETED	Press DELETE again to delete the name and series of tracks. DELETED appears, indicating that the name and series of tracks are deleted
CD	Press CD to exit the memory function

Note: The display indicates whether BeoSound 3000 memory is empty, EMPTY, or full, FULL.

Looking after BeoSound 3000

Normal maintenance, such as cleaning the BeoSound 3000, is the responsibility of the user. To achieve the best result, please follow the instructions.

Please make sure to treat the glass doors with great care. If they crack or chip, or if they are damaged in any other way, they should be replaced immediately as they could otherwise cause bodily harm. You can order replacement doors through a Bang & Olufsen retailer.

Cleaning BeoSound 3000

Before you clean the BeoSound 3000, we recommend that you disconnect it from the mains to prevent the glass doors from opening and closing. While the BeoSound 3000 is disconnected, you can open or close the glass doors manually. It requires only a little, gentle force to do so.

Use a soft, dry cloth to wipe dust off the BeoSound 3000.

The glass doors can be removed and cleaned on the inside, if required. To remove the glass doors, simply grip them tightly, one at a time, while they are open and gently but firmly unhook them from their four fastening points, pulling outwards. To clean the glass doors, we recommend that you use a mild window cleaner.

Fasten the doors again as described earlier in this guide. Leave the doors half-way open before reconnecting the BeoSound 3000 to the mains.

Handling your CDs



No solvents or abrasive cleaners should ever be used on the CD and always wipe the CD in a straight line from centre to edge.

Note: Handle CDs with care, if the CD is always held by its edges and placed in its original cassette when out of the BeoSound 3000, no cleaning will be required.

Should the CD become soiled by fingerprints, dust or dirt, it can be wiped clean with a lint-free, soft, dry cloth. Avoid extreme heat and humidity, and never write on your CDs.

NOTE! Do not use alcohol or other solvents to clean any part of the BeoSound 3000. We do not recommend using special cleaning CDs in the BeoSound 3000.

Although designed primarily for close-up operation, the BeoSound 3000 can also be operated from a distance. The Beo4 remote control operates all the primary functions in your BeoSound 3000.

With Beo4, you can switch on or off, select radio stations or CD tracks. It is also possible to switch on the special random and repeated playback functions in the CD player as well as adjust the sound.

If your BeoSound 3000 is used together with other Bang & Olufsen products, please turn to the User's guides delivered with these products for further explanation.



- | | |
|---------------|---|
| RADIO | Press to switch on the radio |
| CD | Press to switch on the CD player |
| ▲ | Step through your radio programs, or tracks on a CD. Press ▲ when RANDOM or REPEAT is shown in the display, to activate the function, and press ▼ to switch it off when the function is displayed |
| ▼ | |
| 0 – 9 | Use the number buttons to key in the exact radio program number or CD track number |
| ◀▶ | Search through a CD |
| STOP | Press to pause playback any time |
| GO | Press to resume playback – The GO buttons equals PLAY on the BeoSound 3000 operation panel |
| LIST | Press to display extra buttons or functions*, e.g. RANDOM or REPEAT* |
| RANDOM | |
| REPEAT | |
| GO | Press to activate the source or function in the Beo4 display |
| ^ | To turn the volume up or down, press in the middle to mute speakers, press again to recall sound |
| v | |
| • | Switch the BeoSound 3000 to standby |

*NOTE! In order to display the relevant extra buttons on the Beo4, you must add them to the Beo4 list of functions:

Add RANDOM and REPEAT to Beo4 to use the random and repeated play function.

Add A.AUX to be able to switch on any other source connected to the BeoSound 3000 AUX-socket.

Please refer to Beo4's own User's Guide for information about how to add extra buttons to the Beo4.

Use BeoSound 3000 with a video system

To use the BeoSound 3000 together with a Bang & Olufsen video system they must be connected by a special Master Link cable, this is a so-called Audio/Video (AV) integrated setup.

If you choose to interconnect your Bang & Olufsen products, you can distribute the sound from your sources throughout your home.

Many different set-ups are available, please contact a Bang & Olufsen retailer for further information.

A fully integrated AV setup

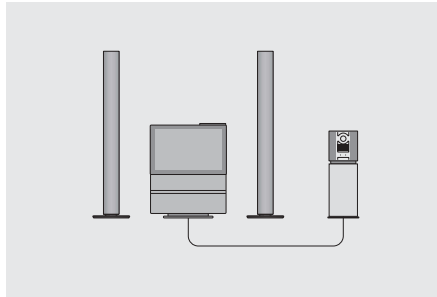

When BeoSound 3000 is used in a fully integrated AV setup, the speakers are connected to the video system, and the video system takes over some of the functions mentioned in this guide. Furthermore, all remote control operations (audio and video) must be directed to the video system, please refer to the guide for the video system for further information.

An AV integrated setup

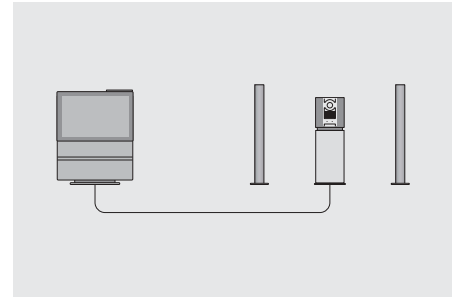

In an AV integrated setup, a pair of active speakers are connected to the BeoSound 3000. You can hear any source you like in the loudspeakers of either system. The BeoSound 3000 and the video system do not have to be placed in the same room.

Use the Beo4 remote control

To play a source in the AV system...

- Press a source button on the Beo4, e.g. CD, RADIO, TV, etc..

Simulcast radio/TV transmissions – to watch a TV program while listening to the sound from a radio program...

- Press TV to switch on the TV
- Press LIST repeatedly until AV* appears in the Beo4 display
- Press RADIO to switch on the radio and start simulcast transmission

Use the Beo4 remote control

To play TV, video or satellite sound on the BeoSound speakers...

- Press LIST until AV* appears in the Beo4 display
- Press TV to hear TV sound, press V TAPE to hear video sound, or press SAT to hear a satellite TV/radio program

To play the radio or CD on the TV speakers...

- Press LIST until AV* appears in the Beo4 display
- Press RADIO to hear radio sound, or press CD to hear a CD

*NOTE! In order to display AV on the Beo4, you must add it to the list of functions. Please refer to the Beo4's own User's guide for information on how to add functions to the Beo4.

Set and enter a PIN code

It is your own choice whether or not to activate the PIN code system.

However, if you choose to activate the system, your BeoSound 3000 is protected against theft with a four-digit PIN code.

The use of a PIN code means that if your BeoSound 3000 is disconnected from the mains for more than 30 minutes, the system can only be activated again by keying in your own personal PIN code.

If the PIN code is not entered, the BeoSound 3000 automatically switches to standby after 3 minutes.

If a wrong PIN code is entered, you get five attempts to key in the code, after which the system is switched off and cannot be switched on for 3 hours.

Should you forget your PIN code, please contact a retailer who can assist you in receiving a Master code from Bang & Olufsen. You need the Master code to reactivate your BeoSound 3000.

Enter the PIN code

If the PIN code system is activated and your BeoSound 3000 is disconnected from the mains, you are requested to key in the four-digit PIN code when the system is first switched on.

PIN _ _ _ _	The cue PIN _ _ _ _ is displayed
0 – 9	Key in your personal PIN code.
PIN * _ _ _	
PIN * * * *	The PIN code is not displayed
RADIO 1	When the four-digit code has been entered, the display returns to the relevant source e.g. RADIO 1

Activate the PIN code system

The PIN code system is easily activated, and you choose the four-digit code yourself.

◀◀	Press twice when the set is in standby
STOP	
NEW PIN	
PIN _ _ _ _	Press STOP to key in a four-digit PIN code of your own choice. NEW PIN appears briefly, and PIN _ _ _ _ appears
0 – 9	Key in a four-digit PIN code of your own choice. The PIN code is not displayed
PIN * _ _ _	
PIN * * * *	
PLAY	Press PLAY to store the PIN code. CONFIRM appears briefly, and PIN _ _ _ _ appears
CONFIRM	
PIN _ _ _ _	
0 – 9	Re-enter your code. The PIN code is not displayed
PIN * * * *	
PLAY	Press PLAY to store. STORED appears, indicating that your PIN code is stored
STORED	

NOTE! If a wrong code is entered the second time, the cue ERROR appears in the display, and you must enter the code again.

Change your PIN code

You can change your PIN code at any time. However, for security reasons it is only possible to change the PIN code five times within a period of 3 hours.

- ◀◀
Press twice when the set is in standby

◀◀

STOP
Press STOP to key in the four-digit PIN code. PIN _ _ _ _ appears

PIN _ _ _ _
- 0 – 9
Key in your personal PIN code. The PIN code is not displayed.

PIN * * * *

NEW PIN ?
- PLAY**
Press PLAY to enter a new PIN code. PIN _ _ _ _ appears

PIN _ _ _ _
- 0 – 9
Key in your new PIN code. The PIN code is not displayed

PIN * * * *
- PLAY**
Press PLAY to store. CONFIRM appears briefly, and PIN _ _ _ _ appears

CONFIRM

PIN _ _ _ _
- 0 – 9
Re-enter your code. The PIN code is not displayed

PIN * * * *
- PLAY**
Press PLAY to store. STORED appears, indicating that your changed PIN code is stored

STORED

Deactivate the PIN code system

You can deactivate the PIN code system at any time. All you need to do is enter your PIN code first and then you can deactivate the system.

- ◀◀
Press twice when the set is in standby

◀◀

STOP
Press STOP to key in the four-digit PIN code. PIN _ _ _ _ appears

PIN _ _ _ _
- 0 – 9
Key in your personal PIN code. The PIN code is not displayed

PIN * * * *

NEW PIN ?
- ▲
Press to switch the display. PIN OFF appears

PIN OFF
- PLAY**
Press PLAY to deactivate the PIN code system. DELETED appears, indicating that the PIN code system is deactivated

DELETED

If you have forgotten your PIN code

If you have forgotten your PIN code, you must contact a retailer who then requests a five-digit Master code from Bang & Olufsen. Once you have keyed in this code, your BeoSound 3000 is operational again and the PIN code system is deactivated.

- PIN _ _ _ _

The cue PIN _ _ _ _ is displayed
- ◀◀
Keep pressed down for 3 seconds to open for master code input
- 0 – 9
Key in the five-digit Master code. DELETED appears, indicating that the PIN code system is deactivated and the set is ready for use

DELETED

For your information...

Your needs as a user are given careful consideration during the design and development process of a Bang & Olufsen product and we strive to make our products easy and comfortable to operate.

Therefore, we hope that you will take the time to tell us about your experiences with your Bang & Olufsen product. Anything which you consider important – positive or negative – may help us in our efforts to refine our products.

Thank you!

Write to: Bang & Olufsen a/s
 Consumer Service
 dept. 7210
 Peter Bangs Vej 15
 DK-7600 Struer

or fax: Bang & Olufsen
 Consumer Service
 +45 97 85 39 11 (fax.)

or e-mail: beoinfo1@bang-olufsen.dk

Visit our Web-site on...
www.bang-olufsen.com

NOTE: This equipment has been tested and found to comply with the limits for a class B digital device, pursuant to part 15 of the FCC Rules. These limits are designed to provide reasonable protection against harmful interference in a residential installation.

This equipment generates, uses and can radiate radio frequency energy and, if not installed and used in accordance with the instructions, may cause harmful interference to radio communications. However, there is no guarantee that interference will not occur in a particular installation. If this equipment does cause harmful interference to radio or television reception, which can be determined by turning the equipment off and on, the user is encouraged to try to correct the interference by one or more of the following measures:

- Reorient or relocate the receiving antenna.
- Increase the separation between the equipment and receiver.
- Connect the equipment into an outlet on a circuit different from that to which the receiver is connected.
- Consult the retailer or an experienced radio/TV technician for help.

This class B digital apparatus meets all requirements of the Canadian Interference-Causing Equipment Regulations.



This product fulfils the conditions stated in the EEU directives 89/336 and 73/23.



The black and yellow label on the compact disc player serves as a warning that the apparatus contains a laser system and is classified as a class 1 laser product. In case any difficulties arise with the compact disc player, please contact a Bang & Olufsen retailer. The apparatus must be opened by qualified service personnel only.



CAUTION: The use of any controls, adjustments or procedures other than those specified herein may result in hazardous radiation exposure.