

Beocord 6002 Type 4851, 4852, 4853, 4854, 4855, 4856, 4857

Beocord 8004 Type 4861, 4862, 4863, 4864, 4865, 4866, 4867

DIAGRAMFORKLARING

De enkelte diagramsider er mærket med et bogstav f. eks. DIAGRAM A.

På diagrammet er der angivet type numre på transistorer og IC'er (f. eks. TR30 BC557B) i de tilfælde, hvor type nummeret er entydigt for komponentens placering i et kredsløb. Hvis positions nummeret er efterfulgt af en stjerne (f. eks. TR101*) **skal** reservedels nummeret benyttes, da denne komponent er specielt udvalgt.

LEDNINGSFORBINDELSER

Ledningsforbindelserne på diagrammet er samlet i »bunder«. De enkelte ledninger er forsynet med koder, der fortæller hvortil de går.

INTERN FORBINDELSE PÅ EN DIAGRAMSIDE



Interne forbindelser på en diagramside angives med et tal. Knækket på ledningen viser i hvilken retning den anden ende af ledningen findes.

FORBINDELSE TIL EN ANDEN DIAGRAMSIDE

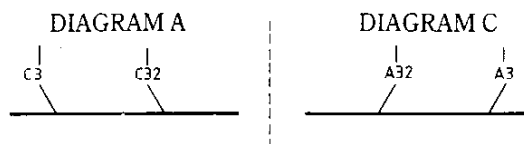

Forbindelsen til en anden diagramside angives med et tal, samt bogstav indikation på det diagram forbindelsen går til.

DIAGRAM EXPLANATION

The individual diagram pages are marked with a letter, e.g. DIAGRAM A.

Type numbers of transistors and ICs (e.g. TR30/BC557B) have been indicated on the diagram in those cases where the type number is unambiguous for the position of the component in a circuitry. If the position number is followed by an asterisk (e.g. TR101*), the spare parts number **must be used** because this component has been especially selected.

WIRING CONNECTIONS

The wiring connections on the diagram are assembled in »bundles«. The individual wires are coded to indicate to where they are leading.

INTERNAL CONNECTION ON ONE DIAGRAM PAGE

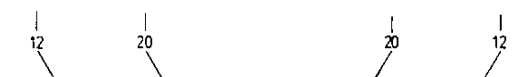

Internal connections on a diagram page are indicated by a number. The bend of the wire indicates in which direction the other end of the wire may be found.

CONNECTION TO ANOTHER DIAGRAM PAGE

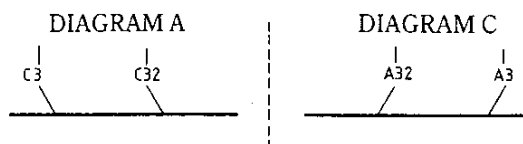

Connections to another diagram page are indicated by a number, as well as by a letter indication of the diagram to which the connections lead.

FOR SERVICE MANUALS
CONTACT:

MAURITRON TECHNICAL SERVICES

www.mauritron.co.uk

TEL: 01844 - 351694

FAX: 01844 - 352554

2450

3538552 INDKLÆBES I SERVICEANVISNINGEN FOR BEOCORD 6000/8002, TYPE 483X/484X
3538552 TO PASTE IN SERVICE MANUAL FOR BEOCORD 6000/8002, TYPE 483X/484X

DIAGRAM B FOR BEOCORD 6002

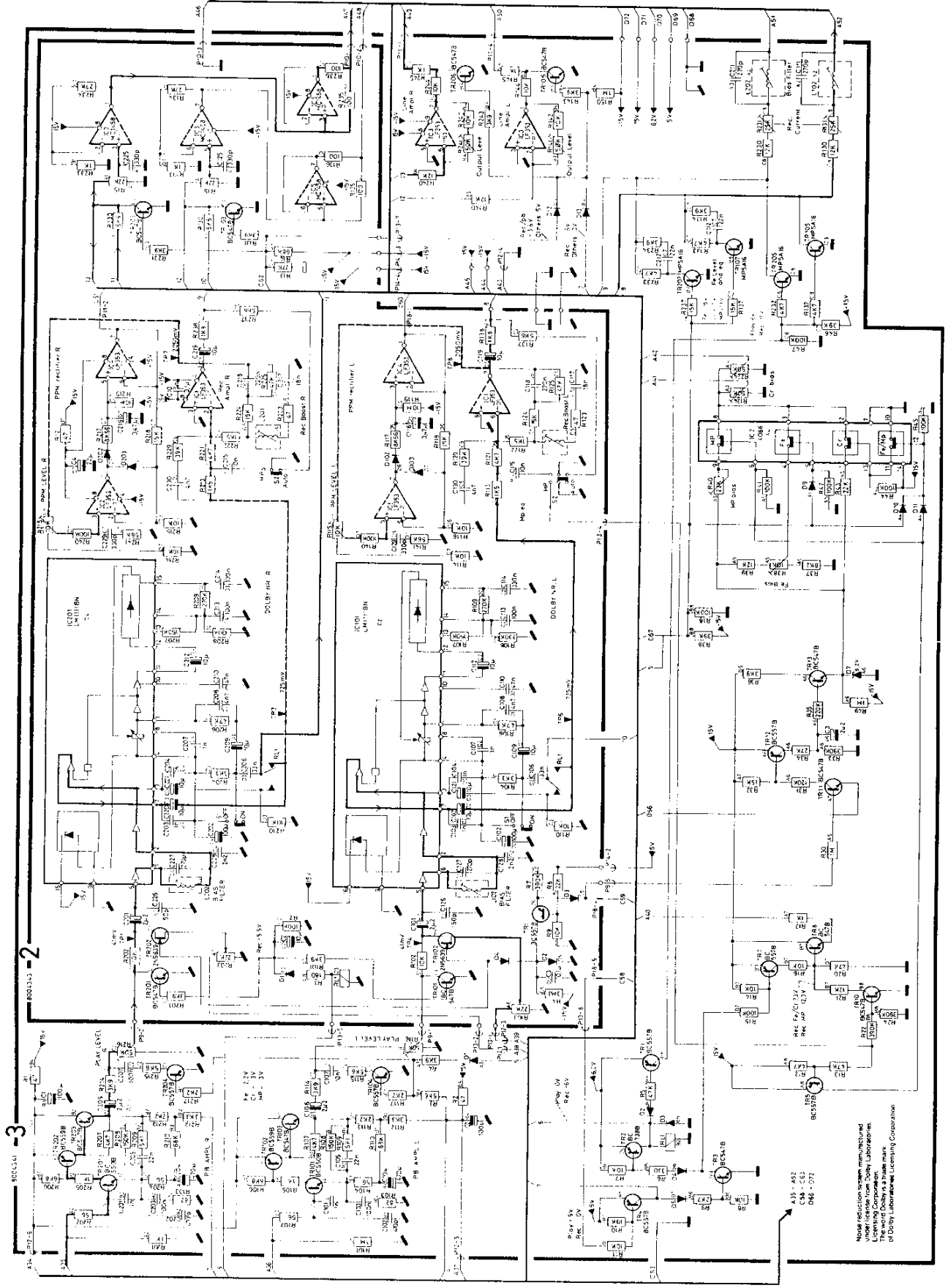

DIAGRAM C FOR BEOCORD 6002

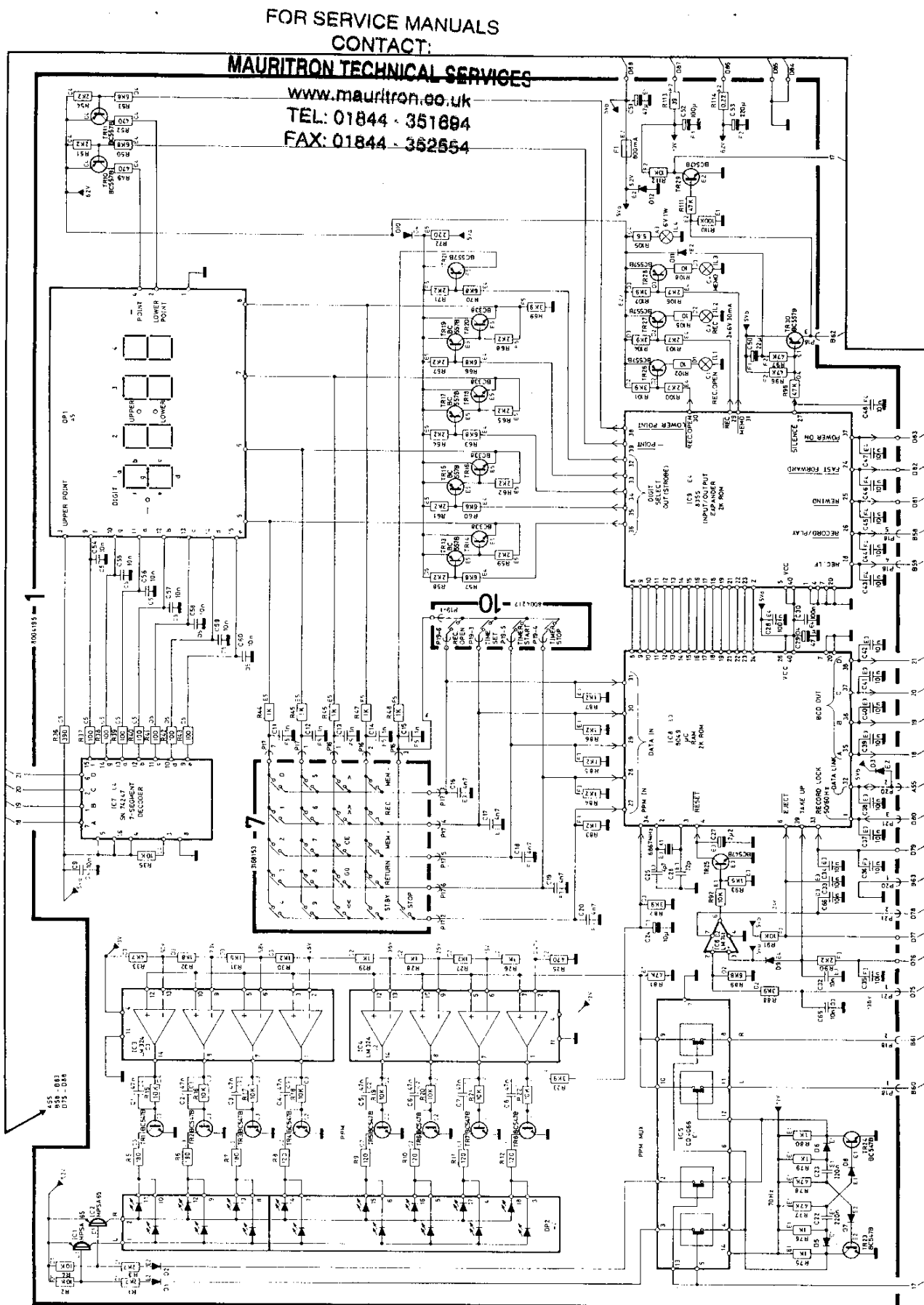
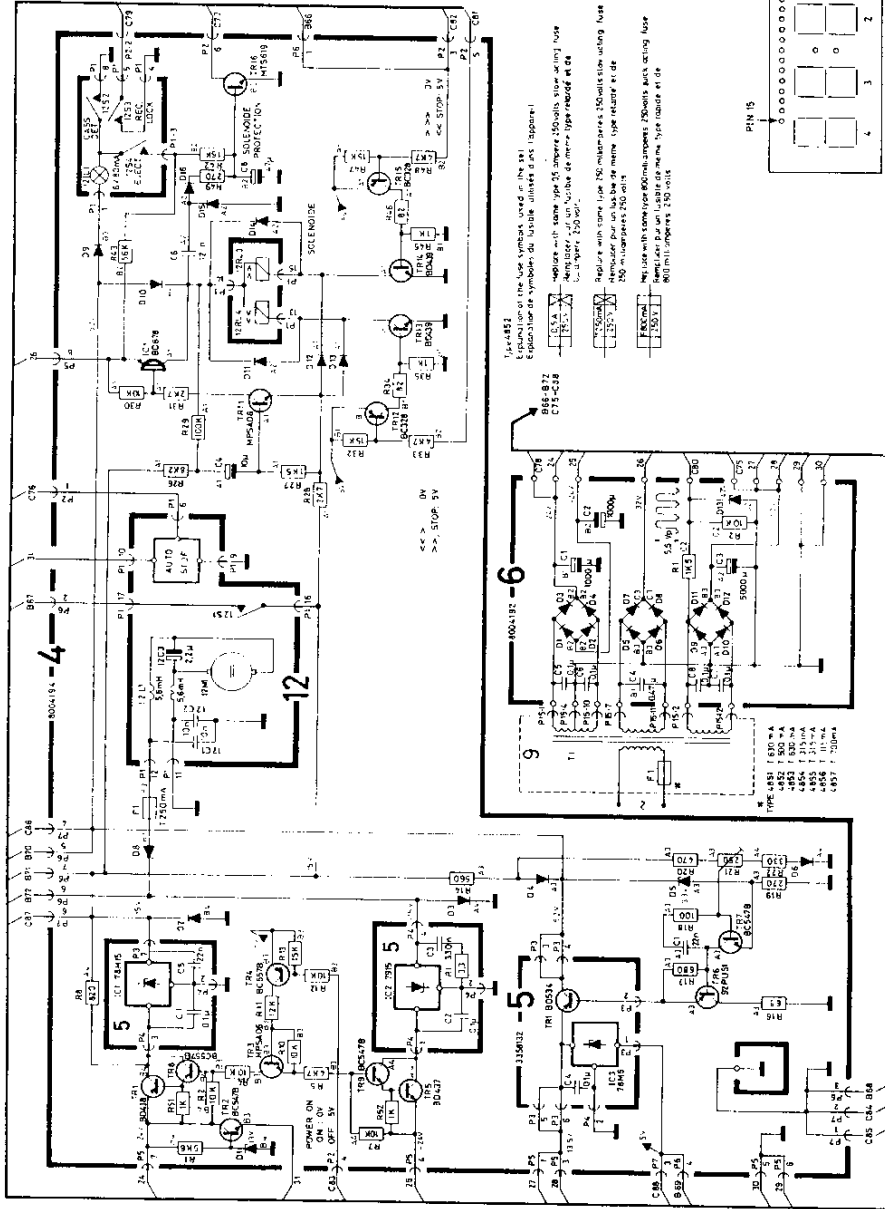

DIAGRAM FOR BEOCORD 6002



Switches:

- 12S1 Fe₂O₃ ON, CrO₂ OFF.
- 12S2 With cass. ON, without OFF.
- 12S3 Rec. ON, Rec lock OFF.
- 12S4 Play ON, Press eject OFF.

PIN ASSIGNMENT (BOTTOM VIEW)

- 1 COMMON CATHODE (POINTS)
- 2 LOWER POINT ANODE
- 3 UPPER POINT ANODE
- 4 - POINT ANODE
- 5 DIGIT 1 ANODE
- 6 DIGIT 2 ANODE
- 7 DIGIT 3 ANODE
- 8 DIGIT 4 ANODE
- 9 SEG. bCATHODE
- 10 SEG. gCATHODE
- 11 SEG. aCATHODE
- 12 SEG. bCATHODE
- 13 SEG. cCATHODE
- 14 SEG. dCATHODE
- 15 SEG. eCATHODE

DECIMAL ON DISPLAY	INPUTS					OUTPUTS					
	D	C	B	A	g	f	e	d	c	b	a
0	0	0	0	0	0	0	0	0	0	0	0
1	0	0	0	1	1	0	1	1	1	1	1
2	0	0	1	0	0	1	0	1	0	1	0
3	0	0	1	0	0	0	1	1	0	1	0
4	0	1	0	1	0	1	0	1	0	1	0
5	0	1	0	1	0	1	0	1	0	1	0
6	0	1	1	0	0	1	0	0	0	0	0
7	0	1	1	0	0	1	0	0	1	1	1
8	1	0	0	0	0	0	0	0	0	0	0
9	1	0	0	1	0	0	1	0	1	0	0
A	1	0	1	1	0	1	0	1	0	1	0
B	1	0	1	1	0	1	0	1	0	1	0
C	1	1	0	1	0	1	0	1	0	1	0
D	1	1	0	1	0	1	0	1	0	1	0
E	1	1	0	1	0	1	0	1	0	1	0

FUNCTION TABLE FOR MICROCOMPUTER 11C8 - 11C9		RESULTS	
CONDITIONS	FUNCTION	11C8	11C9
PIN 4	3.3	0	2.4 25 26 27 28 37 30 29
1	STAND BY	1	1 0 0 1
1	REC OPEN	1	1 0 0 1
1	RECORD	0	0 1 1 0 0 0
1	STOP	1	1 1 0 0 0 1
1	▶▶	0	1 1 0 0 0 1
1	◀◀	1	0 1 0 0 0 1
1	>	0	0 1 1 0 0 1
1	<	1	1 0 1 0 0 1

FOR SERVICE MANUALS
CONTACT:
MAURITRON TECHNICAL SERVICES
www.mauritron.co.uk
TEL: 01844 - 351694
FAX: 01844 - 352554

DIAGRAM A FOR BECORD 8004

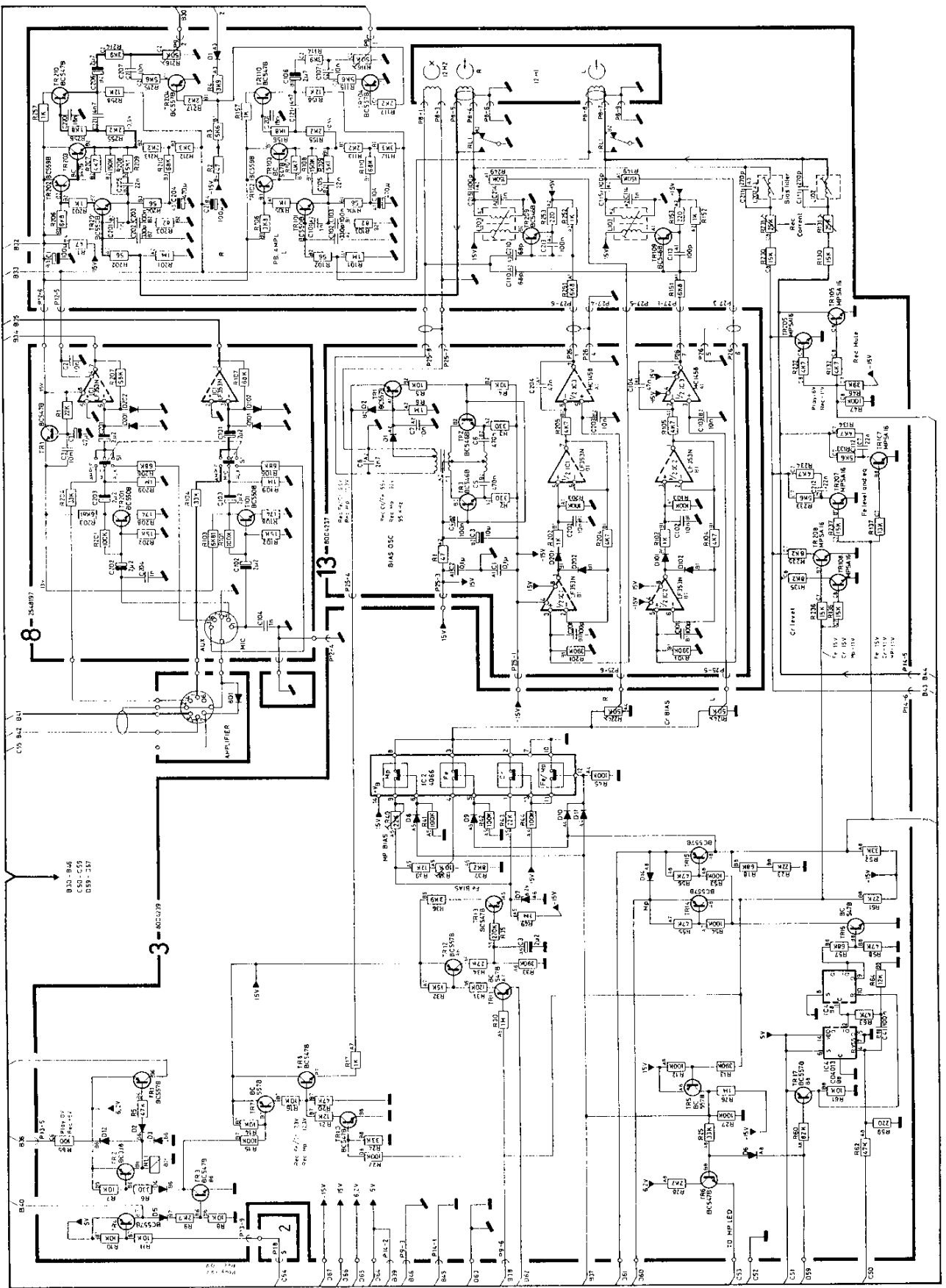

FOR SERVICE MANUALS
 CONTACT:
MAURITRON TECHNICAL SERVICES
 www.mauritron.co.uk
 TEL: 01844 - 351694
 FAX: 01844 - 352554

DIAGRAM B FOR BEOCORD 8004

FOR SERVICE MANUALS
CONTACT:
MAURITRON TECHNICAL SERVICES
www.mauritron.co.uk
TEL: 01844 - 351694
FAX: 01844 - 352554

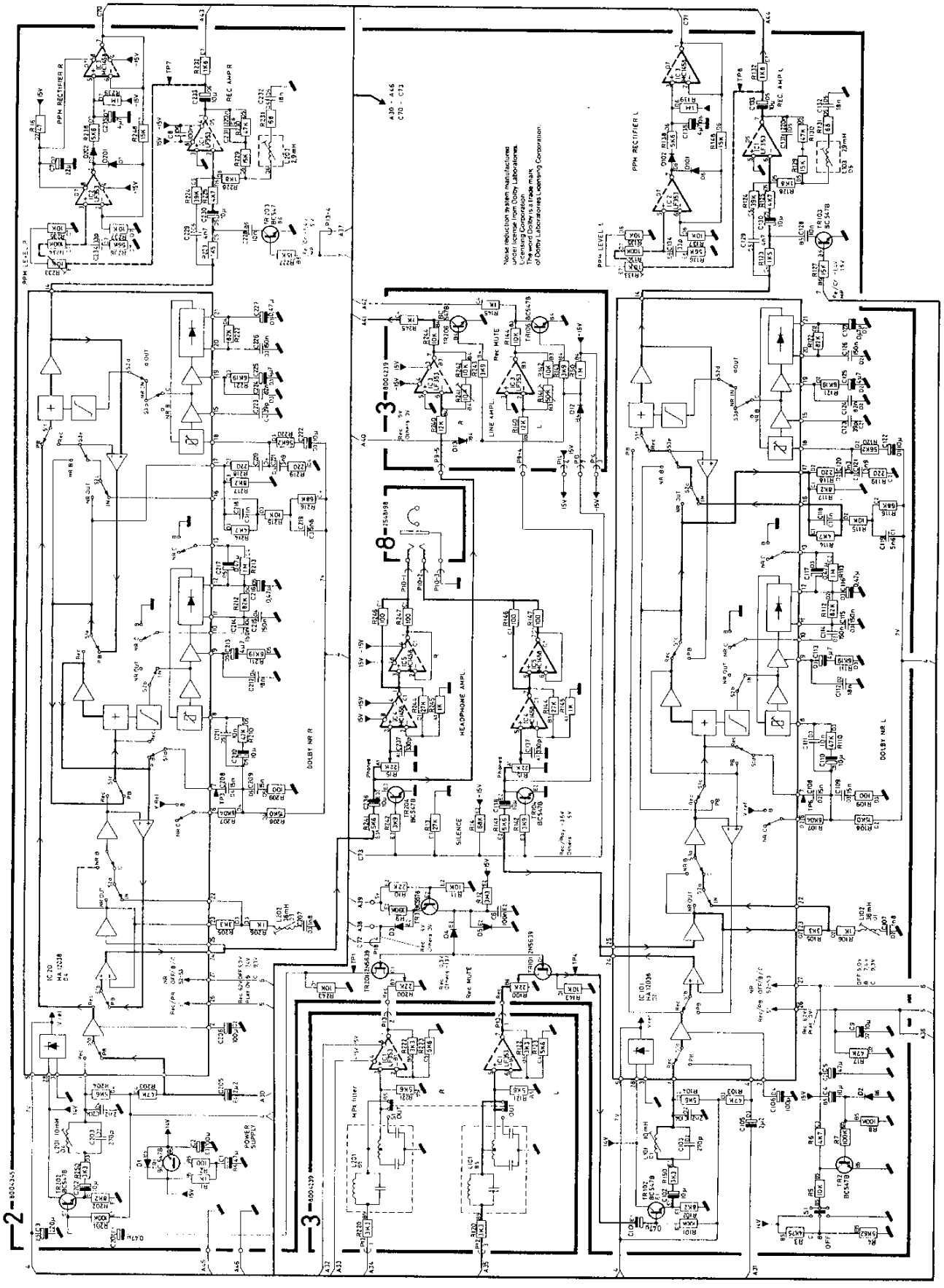

DIAGRAM C FOR BEOCORD 8004

FOR SERVICE MANUALS

CONTACT:

MAURITRON TECHNICAL SERVICES

www.mauritron.co.uk

TEL: 01844 - 351694

FAX: 01844 - 352554

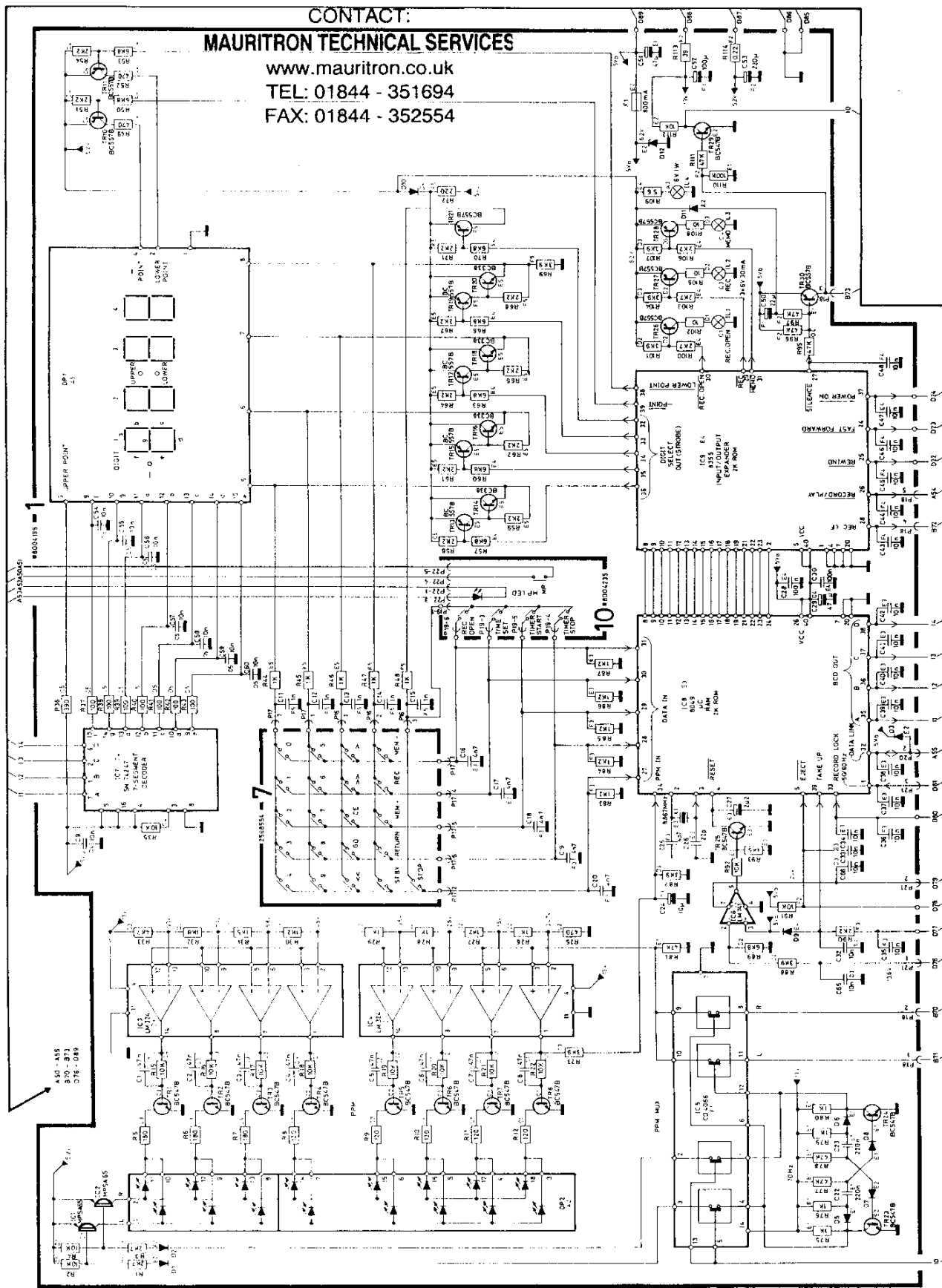

Bang & Olufsen

DIAGRAM D FOR BEOCORD 8004

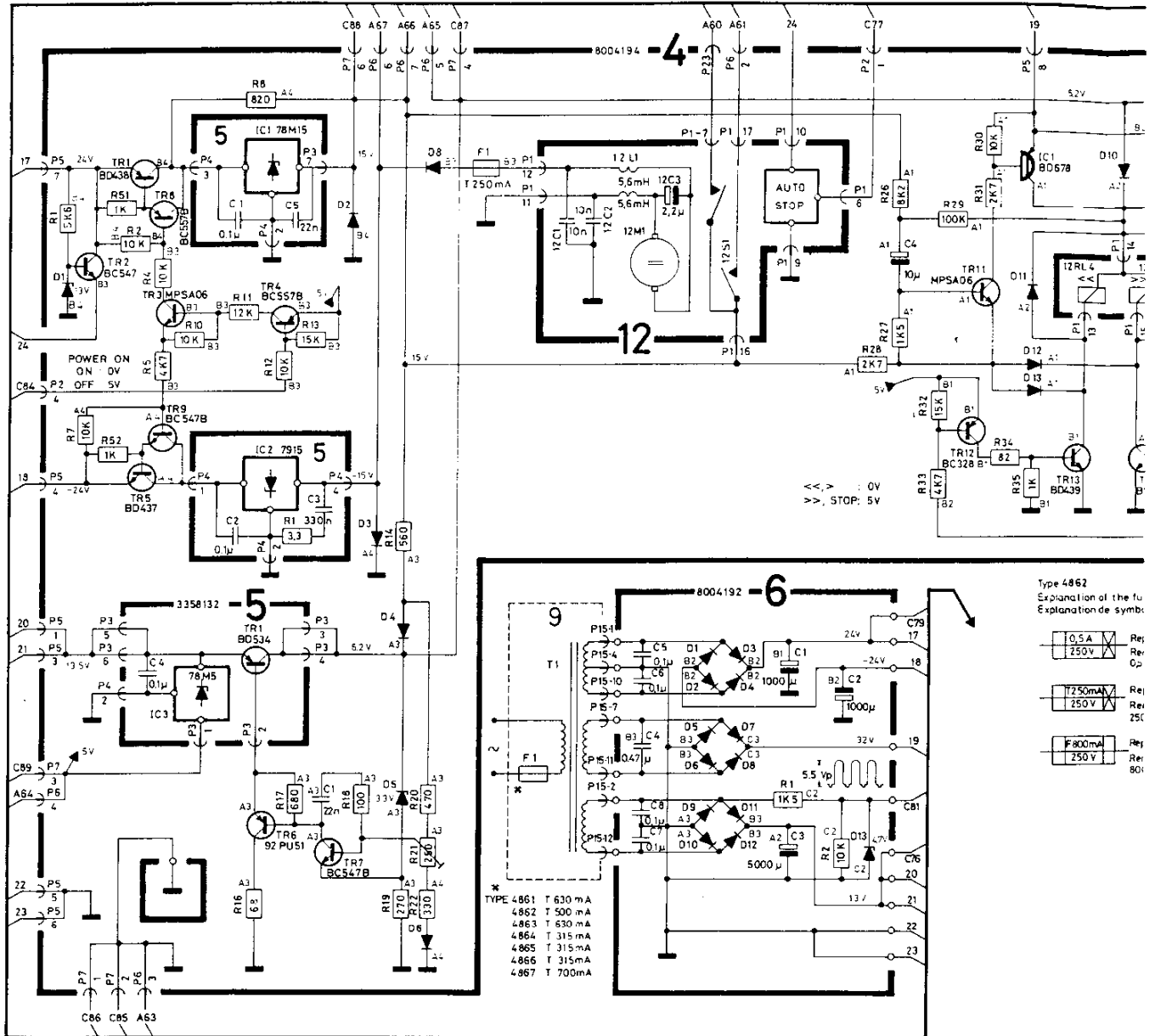

FOR SERVICE MANUALS
CONTACT:
MAURITRON TECHNICAL SERVICES
www.mauritron.co.uk
TEL: 01844 - 351694
FAX: 01844 - 352554

FUNCT	CONDI	
	11C8	11C
PIN	4	3
	1	
	1	1
	1	1
	1	
	1	
	1	1

BECCORD 6002 LIST OF TRANSISTORS

FOR SERVICE MANUALS
CONTACT:
MAURITRON TECHNICAL SERVICES
www.mauritron.co.uk
TEL: 01844 - 351694
FAX: 01844 - 352554

19	20	24	31	32			
1TR1-8	8320097 20	BC 547B		3TR12	8320152 20	BC 557B	
1TR10-13	8320152 20	BC 557B		3TR13	8320097 20	BC 547B	
1TR14	8320329 20	BC 338- 25/18		3TR101/201	8320344 20	BC 550B	
1TR15	8320152 20	BC 557B		3TR102/202	8320069 20	BC 559B	
1TR16	8320329 20	BC 338- 25/18		3TR103/203	8320097 20	BC 547B	
1TR17	8320152 20	BC 557B		3TR104/204	8320152 20	BC 557B	
1TR18	8320329 20	BC 338- 25/18		3TR105/205	8320366 19	MPS A16	
1TR19	8320152 20	BC 557B		3TR106/206	8320097 20	BC 547B	
1TR20	8320329 20	BC 338- 25/18		3TR107/207	8320366 19	MPS A16	
1TR21	8320152 20	BC 557B		3TR109/209	8320237 20	BC 546B	
1TR23-25	8320097 20	BC 547B		4TR1	8320428 32	BD 438	
1TR26-28	8320152 20	BC 557B		4TR2	8320097 20	BC 547B	
1TR29	8320097 20	BC 547B		4TR3	8320321 19	MPS A06	
1TR30	8320152 20	BC 557B		4TR4	8320152 20	BC 557B	
2TR1	8320152 20	BC 557B		4TR5	8320427 32	BD 437	
2TR101/201	8320097 20	BC 547B		4TR6	8320423 19	92 PU51	
2TR102/202	8320396 24	2N 5639 24 MPF 4392		4TR7	8320097 20	BC 547B	
2TR103/203	8320097 20	BC 547B		4TR8	8320152 20	BC 557B	
3TR1	8320152 20	BC 557B		4TR9	8320097 20	BC 547B	
3TR2	8320331 20	BC 328- 25/18		4TR11	8320321 19	MPS A06	
3TR3	8320097 20	BC 547B		4TR12	8320331 20	BC 328- 25/18	
3TR4-7	8320152 20	BC 557B		4TR13-14	8320441 32	BD 439	
3TR8-11	8320097 20	BC 547B		4TR15	8320331 20	BC 328- 25/18	
				4TR16	8320457 20	MTJ 619	
				5TR1	8320369 31	BP534	

LIST OF DIODES

209	215	217	218				

1D1-9	8300058	217	SFD 184	4D2-3	8300023	209	1N 4002/RL
		215	1N 4148				
		209	1N 4148	4D4	8300058	217	SFD 184
						215	1N 4148
1D10	8300189	218	BAV 19			209	1N 4148
		218	BA 219/TB	4D5	8300135	209	ZPD 3.3V5%
1D11	8300058	217	SFD 184			209	BZX 79C3V3
		215	1N 4148			209	BZX 83C3V3
		209	1N 4148	4D6	8300058	217	SFD 184
1D12	8300201	209	ZPD 6.2V5%			215	1N 4148
		209	BZX 79C6V2			209	1N 4148
		209	BZX 83C6V2	4D8-11	8300023	209	1N 4002/RL
1DP1	8330011		FCS 8499	4D12	8300058	217	SFD 184
1DP2	8330003		FNA 0098			215	1N 4148
						209	1N 4148
2D1-103/203	8300058	217	SFD 184	4D14	8300023	209	1N 4002/RL
		215	1N 4148				
		209	1N 4148	4D15-16	8300058	217	SFD 184
3D1-2	8300058	217	SFD 184			215	1N 4148
		215	1N 4148			209	1N 4148
		209	1N 4148	6D1-8	8300023	209	1N 4002/RL
3D3	8300189	218	BAV 19	6D9-12	8300294	209	MR 501 RL
		218	BA 219/TB			209	1N 5401
3D4-5	8300058	217	SFD 184			209	1N 5401 RL
		215	1N 4148	6D13	8300036	209	ZPD 4.7V5%
		209	1N 4148			209	BZX 79C4V7
3D7	8300173	209	ZPD 8V2			209	BZX 83C4V7
		209	BZX 79C8V2	8D1-102/202	8300058	217	SFD 184
		209	BZX 83C8V2			215	1N 4148
3D9-13	8300058	217	SFD 184			209	1N 4148
		215	1N 4148	13D1-102/202	8300058	217	SFD 184
		209	1N 4148			215	1N 4148
4D1	8300218	209	ZPD 13C5%			209	1N 4148
		209	BZX 79C				
			13V0				
		209	BZX 83C				
			13V0				

FOR SERVICE MANUALS
CONTACT:
MAURITRON TECHNICAL SERVICES

www.mauritron.co.uk

TEL: 01844 - 351694

FAX: 01844 - 352554

BEACORD 8004 LIST OF TRANSISTORS

19 	20 	24 	102 	103 	125 	209 	215
217 	227 						

FOR SERVICE MANUALS
CONTACT:

MAURITRON TECHNICAL SERVICES

www.mauritron.co.uk
TEL: 01844 - 351694
FAX: 01844 - 352554

LIST OF IC's

LIST OF DIODES

2TR1-2	8320097	20	BC 547B	3TR14-15	8320152	20	BC 557B
2TR3	8320152	20	BC 557B	3TR16	8320097	20	BC 547B
2TR101/201	8320396	24	2N 5639	3TR17	8320152	20	BC 557B
2TR102/202	8320097	20	BC 547B	3TR108/208	8320366	19	MPS A16
2TR104/204				2TR110/210	8320097	20	BC 547B
3TR6	8320097	20	BC 547B				
2IC4	8340048	103	MC 1458 CP1 103 SN 72558	3IC1Δ	8340195	103	LF 353 N 103 TL 072 CP 103 μAF 772 TC
2IC101/201	8340506	125	HA 12038	3IC4Δ	8340176	102	CD4013BCN 102 MC4013BCP 102 HEF 4013BP
2D1-102/202	8300058	217	SFD 184 215 1N 4148 209 1N 4148	3D6-14	8300058	217	SFD 184 215 1N 4148 209 1N 4148
				10D1	8330038	227	MW 57124

Other semiconductors for Beocord 8004 see Beocord 6002.

Δ betyder at statisk elektricitet kan ødelægge komponenten.

Δ indicates that static electricity may destroy the component.

Δ bedeutet, daß statische Elektrizität die Komponente zerstören kann.

Modules for Beocord 6002

01	8004195	Microcomputer	09	8013213	Transformer, 127V type 4853, 4863
02	8004343	Rec/Dolby			
03	8004341	Play-back	09	8013214	Transformer, 220V type 4854, 4864
04	8004194	Power supply			
05	3358132	Power unit	09	8013215	Transformer, 240V type 4855, 4865
06	8004192	Rectifier			
07	3168153	Primary keyboard	09	8013216	Transformer, 240V type 4856, 4866 AUS.
08	2548198	Input ampl.			
09	8013211	Transformer, 114V type 4851, 4861	09	8013247	Transformer, 105V type 4857, 4867 JAP.
09	8013212	Transformer, 120V type 4852, 4862	10	8004217	Secondary Keyboard
			13	8004237	Bias

Modules for Beocord 8004

02	8004345	Rec/Dolby	07	2568554	Primary Keyboard
03	8004239	Play-back	10	8004235	Secondary Keyboard

Andre moduler til Beocord 8004, se Beocord 6002.
Other modules for Beocord 8004 see Beocord 6002.

List of parts for Beocord 6002

004	2560128	Profile
0039	3164360	Panel
0040	3164528	Cover, complete
0065	3454250	Bottom plate
0801	3122096	Bracket
0802	7210221	Socket 7 contact DIN
12H1	8600068	Tape head

Ander dele til Beocord 6002, se Beocord 8002.
Other parts for Beocord 6002 see Beocord 8002.

List of parts for Beocord 8004

004	2560129	Profile
0039	3164499	Panel
0040	3164529	Cover, complete
0801	3122096	Bracket
0802	7210221	Socket 7 contact DIN

Special parts for 02 module

2S1	7400232	Switch
2L201	8022111	10 mH
2L202	8022127	36 mH
2L203	8022059	2.8 mH

Ander dele til Beocord 8004, se Beocord 8002.
Other parts for Beocord 8004 see Beocord 8002.

FOR SERVICE MANUALS
CONTACT:
MAURITRON TECHNICAL SERVICES

www.mauritron.co.uk
TEL: 01844 - 351694
FAX: 01844 - 352554

ELEKTRISKE JUSTERINGER

Elektriske justeringer af Beocord 6002/8004 foretages som vist side 6-4, 6-5 og 6-6. Enkelte justeringer i Beocord 8004 er ændret i forhold til Beocord 8002 (se nedennævnte).

Optagehæv

Denne justering skal være meget nøjagtig.

CrO₂ bånd ilægges.

Tonegenerator tilsluttes AMPLIFIER indgangen, og indstilles til at afgive 333 Hz og ca. 30 millivolt.

LF voltmeter tilsluttes 2TP7E7 (2TP8E7).

Record pause aktiveres.

Record potentiometrene indstilles til der måles 100 millivolt i 2TP7 (2TP8).

LF voltmeter tilsluttes 2TP3D4 (2TP6D2).

Spændingen i 2TP3 (2TP6) aflæses og noteres.

Tonegeneratorens frekvens ændres til 19 kHz.

Record potentiometrene reguleres således, at spændingen i 2TP3 (2TP6) er nøjagtig den samme ved 19 kHz som ved 333 Hz.

LF voltmeter tilsluttes 2TP7E7 (2TP8E7).

Med 2L203D6 (2L103D5) justeres til der måles 1,35 volt i 2TP7 (2TP8)

(svarer til +22,7 dB ved 19 kHz i forhold til 333 Hz).

FOR SERVICE MANUALS
CONTACT:
MAURITRON TECHNICAL SERVICES

www.mauritron.co.uk

TEL: 01844 - 351694

FAX: 01844 - 352554

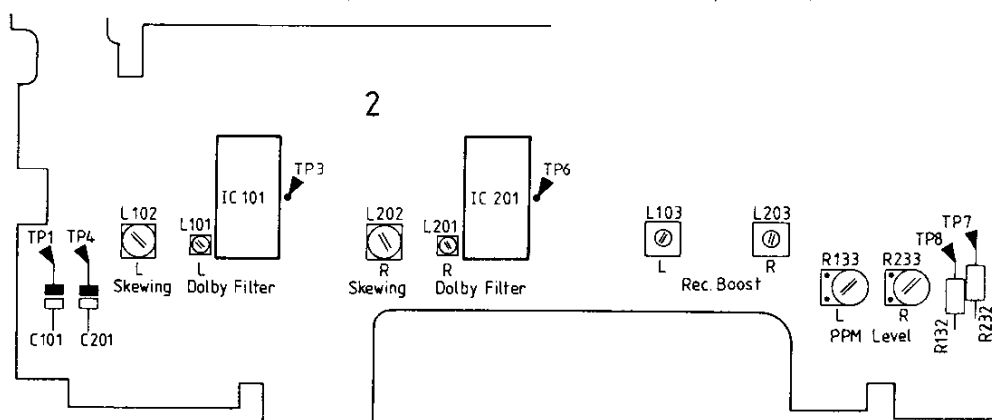

PPM

Tonegeneratoren indstilles til at afgive 333 Hz og ca. 300 millivolt.

LF voltmeter tilsluttes 2TP3D4 (2TP6D2).

Record pause aktiveres.

Record potentiometrene indstilles til der måles 725 millivolt i 2TP3 (2TP6).

2R233E7 (2R133E7) justeres indtil +2 dB lysdioden netop tænder.

Dolby filter

Der monteres en modstand på 1 Mohm fra slettehovedet til den negative pol på 2C201D1 (2C101D1) (2TP1 (2TP4)).

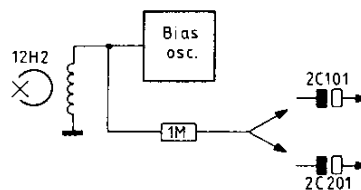

Record potentiometrene stilles i maximum.

REC. aktiveres (uden LF signal tilført).

Oscilloscop tilsluttes 2TP3D4 (2TP6D2).

2L201D4 (2L101D1) justeres til minimum.

1 Mohm afmonteres.

Tilføjelse:

Skewing

Dolby NR omskifteren stilles i stilling NR C.
 Tonegenerator tilsluttes AMPLIFIER indgangen, og indstilles til at afgive 19,9 kHz (± 200 Hz) og 200 millivolt.
 LF voltmeter tilsluttes 2TP3D4 (2TP6D2).
 REC aktiveres.
 Record potentiometrene indstilles til der måles 300 millivolt i 2TP3 (2TP6).
 2L202D4 (2L102D1) justeres til minimum udslag på LF voltmeteret i 2TP3 (2TP6).

ELECTRICAL ADJUSTMENTS

Electrical adjustments of Beocord 6002/8004 are made as shown on page 6-4, 6-5, and 6-6. Some adjustments in the Beocord 8004 have been changed in relation to Beocord 8002 (see below).

Record boost

This adjustment must be very accurate.
 Load CrO₂ tape.
 Connect AF voltmeter to 2TP7E7 (2TP8E7).
 Activate record pause.
 Adjust the record potentiometers until a reading of 100 mV is obtained in 2TP7 (2TP8).
 Connect AF voltmeter to 2TP3D4 (2TP6D2).
 Take a reading of the voltage in 2TP3 (2TP6) and write it down.
 Change the tone generator frequency to 19 kHz.
 Adjust the record potentiometers in such a way that the voltage in 2TP3 (2TP6) is exactly the same at 19 kHz as at 333 Hz.
 Connect an AF voltmeter to 2TP7E7 (2TP8E7).
 Adjust with 2L203D6 (2L103D5) until 1,35 V is measured in 2TP7 (2TP8) (corresponds to +22,7 dB at 19 kHz in relation to 333 Hz).

FOR SERVICE MANUALS

CONTACT:

MAURITRON TECHNICAL SERVICES

www.mauritron.co.uk
 TEL: 01844 - 351694
 FAX: 01844 - 352554

PPM

Set the tone generator to generate 333 Hz and approx. 300 mV.
 Connect AF voltmeter to 2TP3D4 (2TP6D2).
 Activate record pause.
 Adjust the record potentiometers until 725 mV is measured in 2TP3 (2TP6).
 Adjust 2R233E7 (2R133E7) until the +2 dB LED is just glowing.

Dolby filter

Fit a 1 Mohm resistor from erase head to the negative pole on 2C201D1 (2C101D1) (2TP1 (2TP4)).
 Adjust record potentiometers to maximum.
 Activate REC. (without AF signal applied).
 Connect oscilloscope to 2TP3D4 (2TP6D2).
 Adjust 2L201D4 (2L101D1) to minimum.
 Remove 1 Mohm resistor.

ADDITION

Skewing

Adjust Dolby NR switch to position NR C.
 Connect tone generator to AMPLIFIER input, and adjust until 19,9 kHz (± 200 Hz) and 200 mV can be read.
 Connect AF voltmeter to 2TP3D4 (2TP6D2).
 Activate REC.
 Adjust record potentiometers until 300 mV in 2TP3 (2TP6) can be read.
 Adjust 2L202D3 (2L102D1) to minimum deflection on AF voltmeter in 2TP3 (2TP6).